

# Installation Guide







# Content

<b>01</b>	<b>Facade solutions with Hardie® Panel and Hardie® Architectural Panel</b>	<b>3</b>	<b>03</b>	<b>Installation of Hardie® Panel and Hardie® Architectural Panel</b>	<b>13</b>
1.1	Product description Hardie® Panel & Hardie® Architectural Panel facade cladding	4	3.1	General	13
1.2	Rainscreen facade system	5	3.2	Aluminium subframes	14
1.3	Classification	6	3.2.1	Technical specifications/details	20
1.4	Tools and Accessories	7	3.3	Cladding of soffits and fascia	26
			3.4	Timber subframes	27
			3.4.1	Fastening to timber battens	29
			3.4.2	Technical specifications/details	32
<b>02</b>	<b>Preparation of Hardie® Panel and Hardie® Architectural Panel</b>	<b>8</b>	<b>04</b>	<b>After Care</b>	<b>38</b>
2.1	Storage and Handling	8	4.1	Maintenance and servicing	38
2.2	Cutting	11	4.2	Final and regular cleaning	38

## 01 Facade solutions with Hardie® Panel and Hardie® Architectural Panel

### Endless design possibilities

Affordable housing is the hot topic of the moment. Land prices are skyrocketing, and construction costs must compensate. The durability, low maintenance requirements, high weather resistance and our 15 year guarantee makes Hardie® Panel & Hardie® Architectural Panel facade panels ideal products for cost-efficient and at the same time attractive facade design.

When it comes to strength, stability and modernity, this facade design is the optimal solution for you. James Hardie offers you cost-effective solutions with attractive design options. The large format and flexible colour schemes bring straightforwardness and uniqueness to your building projects. Whether you have a large or small scale project, Hardie® Panel & Hardie® Architectural Panel cladding can help you achieve the best possible results.

### Durability

Thanks to our technological innovations, Hardie® products outperform other cladding products. Hardie® fibre cement is impact, fire, insect and weather resistant. Hardie® Panel & Hardie® Architectural Panel are designed to withstand European climates and weathering without sacrificing dimensional stability. The moisture resistance maintains all product properties in its dry state, even when our fibre cement is exposed to moisture and humidity.

### The formulation

Hardie® Panel products consist of cement reinforced with cellulose fibres, sand and water. Added to this is a small number of additives that give Hardie® products their unique, long-lasting properties.



## 1.1 Product description Hardie® Panel & Hardie® Architectural Panel facade cladding

Purposely designed as external cladding for commercial buildings in both new build and renovation. Hardie® Panel and Hardie® Architectural Panel can be used as part of a rainscreen cladding system fixed to timber, aluminium or steel sub-frames, using corrosion resistant fixings. Our cladding can be installed with or without insulation.

The products are available in modern standard colours. We offer a custom colouring service in almost any colour to meet your specific project requirements.

### Textures and colours

Hardie® Panel is available in a lightly textured finish. For individual and modern facades, Hardie® Architectural Panel is available in various textured surfaces.

Hardie® Architectural Panel Metallics combines the look of a fibre cement facade cladding with a special metallic look that comes in 6 metallic colours.

A 15-year guarantee testifies our confidence in the durable and low-maintenance surface and panel. The texture of the facade panel is particularly visible under incident sunlight. Differences in structure or gloss level have no effect on the general product properties and give the facade a natural, lively appearance.

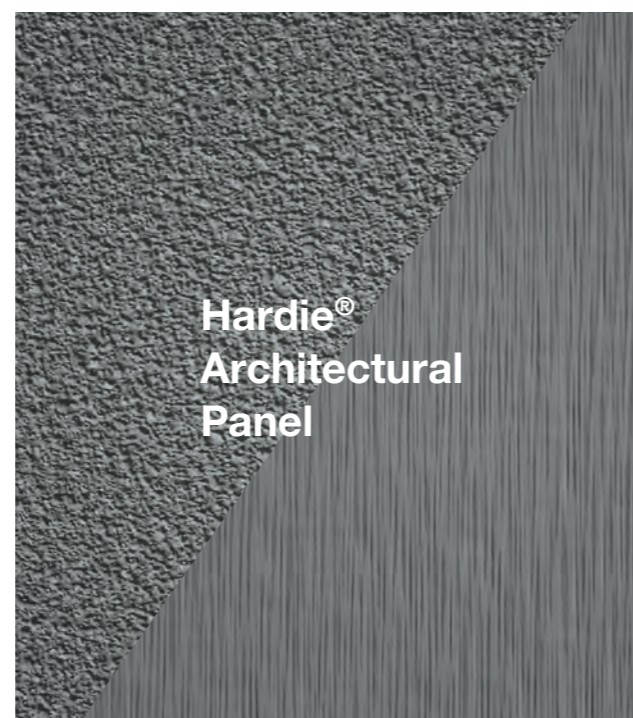

## 1.2 Rainscreen facade system

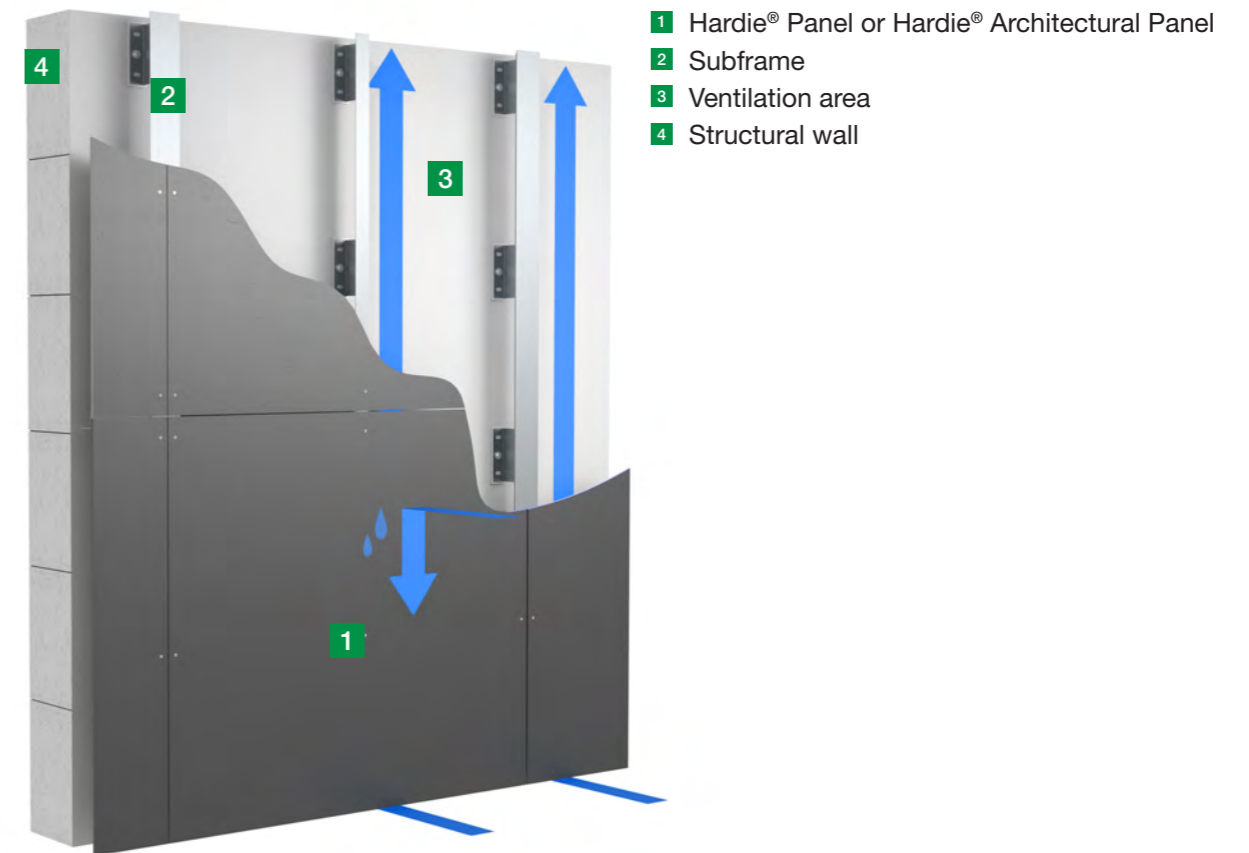

### Benefits

#### For use

- Low maintenance
- A2-s1, d0
- Energy efficiency

#### Installation

- Dry installation
- Easy and full year installation
- Easy deconstruction

#### Building physics

- Rapid drying
- Temperature control

### Principle of rainscreen facade

Cladding with Hardie® Panel boards must always be carried out as a ventilated facade with minimum 20 mm distance between the cladding and the rear lining (insulation material). However, in special situations (e.g. high rise buildings) local regulations may demand a larger ventilation gap. Inlet and outlet openings must have a cross section of at least 100 cm<sup>2</sup>/m.

## 1.3 Classification

The quality properties of Hardie® Panel & Hardie® Architectural Panel are continuously monitored by the company itself and are also subject to constant quality control by material testing institutes (external monitoring).

Properties	Hardie® Panel Hardie® Architectural Panel Metallics		Hardie® Architectural Panel	
Thickness (EN 12467)	8 ± 0.8 mm	11 ± ±-1.1 mm	8 + 1.2/- 0.8 mm	11 + 1.65/-1.1 mm
Category and Class (EN 12467)	Category A, Class 2			
Fire Classification (EN 13501-1)	A2-s1, d0			
Length*	Raw: 3048 ± 5 mm / Net.: 3038 mm			
Width*	Raw: 1220 ± 3.66 mm / Net.: 1210 mm			
Nominal Squareness (DIN EN 12467)	Level I			
Gross Density	~ 1300 kg/m <sup>3</sup>			
Mass per unit area	10.2 kg/m <sup>2</sup>	14.4 kg/m <sup>2</sup>	10.2 kg/m <sup>2</sup>	14.4 kg/m <sup>2</sup>
Thermal Conductivity	$\lambda_{10, tr} = 0.23 \text{ W/mK}$			
Thermal Resistance	$R_{10, tr} = 0.035 \text{ m}^2\text{K/W}$	$R_{10, tr} = 0.048 \text{ m}^2\text{K/W}$	$R_{10, tr} = 0.035 \text{ m}^2\text{K/W}$	$R_{10, tr} = 0.048 \text{ m}^2\text{K/W}$
Flexural Strength (EN 12467)	16.0 MPa perpendicular to fibre direction 11.0 MPa parallel to fibre direction	17.7 MPa perpendicular to fibre direction 11.9 MPa parallel to fibre direction	17.8 MPa perpendicular to fibre direction 11.4 MPa parallel to fibre direction	17.0 MPa perpendicular to fibre direction 11.8 MPa parallel to fibre direction
Young's modulus	6200 N/mm <sup>2</sup>		5100 N/mm <sup>2</sup>	
Linear strain, 30–90 % relative humidity	≤ 0.5 mm/m**			
Impact Resistance (soft and hard impact as per EAD 090062-00-0404)***	Only for 11mm			

\* trimming of 5mm per side from the raw size is recommended for optimal squareness

\*\* between 30 % and 90 % rel. humidity

\*\*\* on timber Aluminium steel

## 1.4 Tools and Accessories

### Hardie™ Seal Edge Sealer



An acrylic coating, available in matching colours, required to seal the cut ends of the facade cladding. Available in 0.5 litre cans.

### Hardie™ Panel Standing Seam Trim



Length: 3000 mm, facade design option. Available in Anthracite Grey and Midnight Black. Other colours available on request.

### Hardie™ Panel Standing Seam End Trim



Length: 3000 mm, facade design option. Available in Anthracite Grey and Midnight Black. Other colours available on request.

### Hardie™ Panel MetalTrim™ Trim

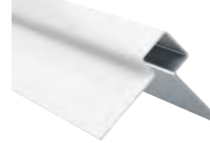

High-quality, powder-coated aluminium profiles for modern exterior corner design. Available in 6 standard colours and custom colour. Length: 3000 mm.

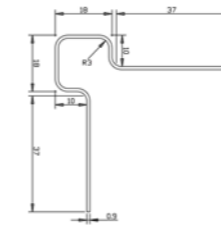

### Profile for Hardie® Panel

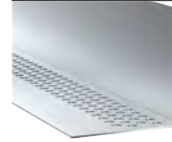

Ventilation profile, for ideal ventilation and protection against rodents. Available in three leg depths: 25 mm, 38 mm and 50 mm, length: 3000 mm.

### Hardie™ EPDM Tape

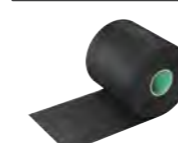

UV-resistant EPDM joint tape for protection against permanent moisture penetration of the wooden subframes. Available in lengths of 20 m and in widths of 60, 80, 100 and 120 mm. Thickness 0.7 mm. Length 20 m.

### Hardie™ Saw Blade



Diamond-tipped saw blade. Available in 160 mm (suitable for 20/16 mm diameter holes), 190 mm (suitable for 30/20 mm diameter holes), 254 mm and 305 mm (suitable for 30 mm diameter holes), 254 mm and 305 mm (suitable for 30 mm diameter holes). For outdoor use only.

### Hardie™ Panel Screws (for wood frame)



A2 stainless steel screws for fastening Hardie® Panel & Hardie® Architectural Panel cladding to wood framing. The screw heads are matched to the colour scheme of the Hardie® Panel & Hardie® Architectural Panel fibre cement panels.

## Supplied by others

### Rivet Spacer Nosepiece



Used to set the rivet off the panel face by 0.3mm

### Universal Joint Profile

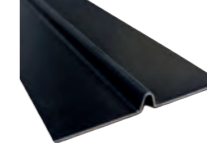

Manufactured from high quality black coated aluminium. To be used on horizontal express joints. Maximum thickness 0.8mm. Length: 3000 mm.

### Rivet (for aluminium subframes)



Aluminium rivet (AlMg<sub>2</sub>) with rivet mandrel made of stainless steel for fastening Hardie® Panel cladding to aluminium subframes.  
8mm Board - 5.0 x 18 x 14mm  
11mm Board - 5.0 x 25 x 16mm

### Centralising Tool



Used on pre-drilled panel to ensure a concentric hole is drilled in the metal subframe behind the panel.

Start your planning with the  
James Hardie sample packs

Order your Hardie® Panel sample now:

[www.jameshardie.co.uk/request-a-sample/hardie-panel-sample-request](http://www.jameshardie.co.uk/request-a-sample/hardie-panel-sample-request)



## Warranty

15-year warranty on Hardie® Panel and Hardie® Architectural Panel and surface coating according to the warranty terms when properly applied as per the installation instructions.

**15 Year**  
Warranty



# 02 Preparation of Hardie® Panel and Hardie® Architectural Panel

## 2.1 Storage and Handling

### Storage



Hardie® Panel and Hardie® Architectural Panel must be stored covered, level, and dry.

Pallets must be protected against rising damp and weathering. Damp products must not be installed, or damage may occur. The cover of the pallets can be reused for dry storage.



A maximum of 5 pallets (with 25 panels each) may be stacked on top of each other. Make sure that the storage woods of the pallets are vertically on top of each other on solid ground.

If the panels are not assembled immediately after delivery to the construction site, they should be stored in a protected area.

### Handling

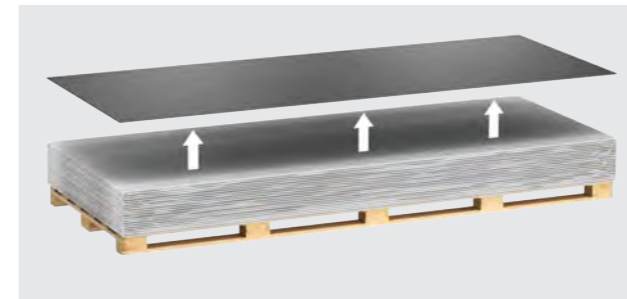

The panels should be lifted straight and not pulled over each other to avoid damage to the surface.



The panel is a two person lift with the board held upright on it's edge.

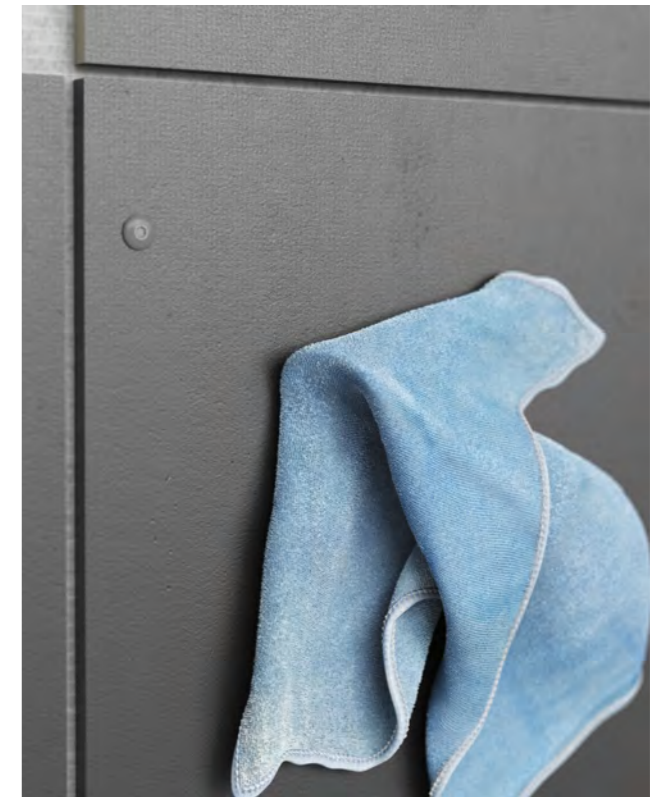

Dust should be removed immediately with a soft cloth such as a microfibre or soft brush.



Avoid the contact with grease/oil & silicone, as these can leave permanent stains. For safety reasons the use of clean gloves is advisable while avoiding staining the panels.

### Edge sealing

All trimmed/cut edges must be sealed with Hardie™ Seal edge sealer. The edge sealant protects the panel from moisture absorption. It is available in all standard colours and custom colour to match the surface.

Before applying the edge sealer, make sure that the edges are clean, dry, and dust-free.

The temperature must be between +5° C and +35° C.

Furthermore, please observe the information given in the product data sheet of the Hardie™ Seal edge sealant.

A paint applicator with a small sponge, if available with a triangular tip, or a fine paint roller is suitable for application, as this is the best way to work in a controlled manner.

**Do not apply the paint over a large area on the front of the facade panels. Wipe off excess paint immediately from the factory coated surface.**

You can also use Hardie™ Seal edge sealer to touch up small scratches or dents no larger than 6 mm. Please use only in small amounts and only on the affected area, as the paint may settle from the panel surface. If the damage is still visible, please replace the facade panel.

Luko sealant is also applicable for use. Please refer to the manufacturers instructions for application.



## 2.2 Cutting

### Tools

The use of Hardie™ Blade saw blades is recommended for great clean cuts and low dust emission. Furthermore, other commercially available polycrystalline diamond saw blades are also suitable for cutting Hardie® fibre cement panels.

The optimum cutting speed for industrial saws should be 40–50 m/s. In general, higher cutting speeds allow for better cutting-edge quality.

#### Overview Hardie™ Blade

Diameter	Ø 160 mm	Ø 190 mm	Ø 254 mm	Ø 305 mm
Cutting width	4 mm	4 mm	4 mm	4 mm
Hole size	20 mm	30 mm	30 mm	30 mm
Rotation/minute	4800	4000	3000	2800



Lower cutting speeds should be used for hand-held circular saws.

When cutting Hardie® Panel & Hardie® Architectural Panel, please consider the following:

- Please always use an EU-approved dust mask (fine dust mask of protection class 2 or 3).
- The panels must always be cut outdoors or indoors with appropriate dust extraction equipment.

**Remaining dust must be removed immediately with a soft cloth such as a microfibre or soft brush. The use of a dust extractor while cutting is mandatory.**



### Cut-outs

Use a jigsaw or a hole saw equipped with carbide, bi-metal, or diamond tipped (e.g. Bosch saw blade type jigsaw blade T 141 HM or equivalent). Cut-outs should always take place before installation on the facade.





When calculating the cutting for the panel, consider the width of the joint (max. 10 mm). Vertical joints must be backed with a support profile or with a support batten. Narrow strips < 250 mm should be avoided. Cut-to-size panel strips with a width of 250 mm must be fastened with two rows of fasteners, observing the minimum corner and edge distances specified in this document.

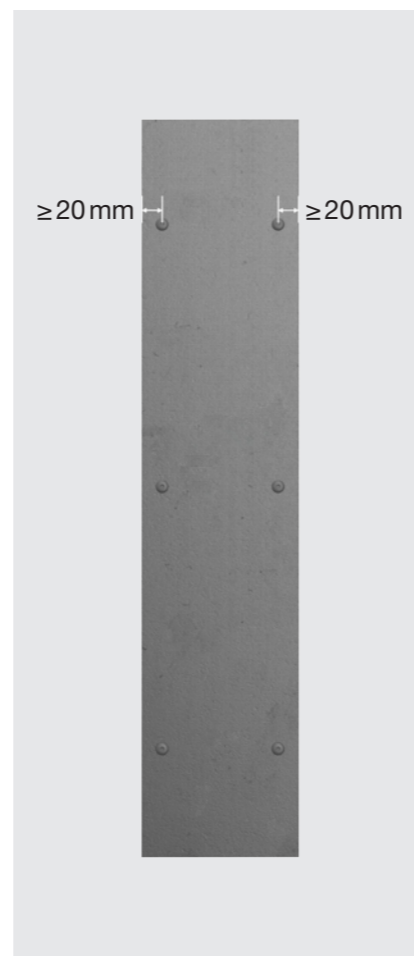

## 03 Installation of Hardie® Panel and Hardie® Architectural Panel

### 3.1 General

#### Construction

James Hardie does not specify the fastening requirements for the framing to the building and will not take the liability of such structural elements. The attachment of the framing should be incorporated into the overall building design and should be approved by the responsible parties.

#### Structure

The structural wall to which Hardie® Panel cladding is to be fixed, must be of sufficient strength and stiffness to satisfy the requirements of the local building regulations. The wall may be made of masonry, timber, or steel. In the case of the latter, a sheathing board must be installed over the frame/ behind the rainscreen facade.

#### Waterproof Membrane

If a waterproof membrane is required, fix to the outer face of the structural wall with an overlap between the layers of membrane of at least 150mm.

#### Preparing the Frame

The subframe creates a ventilation cavity (minimum 20mm) between Hardie® Panel and the substrate, and would normally run vertically. The top and base of the frame must be finished with a perforated enclosure.

If horizontal framing is required, allowances must be made to maintain ventilation.

#### Movement joints

The movement joints of the building must be taken over in the subframes as well as in the facade cladding.

Due to the dimensional stability of the Hardie® Panel under the influence of moisture, no further movement joints are needed for the cladding.

#### Rear ventilation cross-section / ventilation openings

Ventilation is provided via the base area of the facade. It must always be ensured that the air flow is guaranteed over the entire height of the facade.

The opening at the base also serves to discharge moisture (through diffusion, condensation, and weathering).

A minimum 10mm air gap is required at the roofline.

A ventilation opening must also be provided above windows and doors with a minimum 10mm air gap underneath the windowsill.

No horizontal profiles may be installed above or below the window openings. These would prevent rear ventilation.

#### Wall penetrations

For penetrations such as pipes, James Hardie recommends using diamond drill bits or carbide-tipped hole saws. Create a hole of at least 6 mm larger than the pipe diameter. The gap might be sealed with a hybrid polymer or acrylic sealant (never with silicone, due to staining over the panels).

### 3.2 Aluminium subframes

In the event of fixing the Hardie® Panel and Hardie® Architectural Panel to an aluminium subframe, the facade panels are preferably fixed to the subframes with a rivet fixing.

The fixing heads are matched to the respective colour of the facade panels.

#### General

Hardie® Panel is not intended as a load bearing or shear element in the wall construction. Items required to be attached to the wall should be supported directly by connections to the structural sheathing and/or framing members, not attached to the cladding as the primary load bearing elements. Lightweight finishing grilles can be bonded to the face of the product using a construction adhesive.

For questions please contact subframe manufacturer.



General set-up

Hardie® Panel and Hardie® Architectural Panel will require both sliding and fixed points. This is to facilitate the characteristic movement of the aluminium sub-frame, minimising the risk of unwanted stress to the panels.

Each board requires 2 fixed points, avoiding corners, drilled with a diameter of 5.1mm. The rest are sliding points (oversized) with a drilling diameter of 9mm.

Holes are pre-dilled with a carbide drill bit, prior to panel being offered up to the sub-frame. The sub-frame also requires pre-drilling but with a metal drill bit, with all holes the same size as the rivet diameter.

For the sliding points, the holes should be drilled with a centralising tool to ensure that the rivet hole is central to the 9mm pre-drilled hole in the board.

**All fixings should have sliding points except for 2 fixed points.**

#### Fixed point

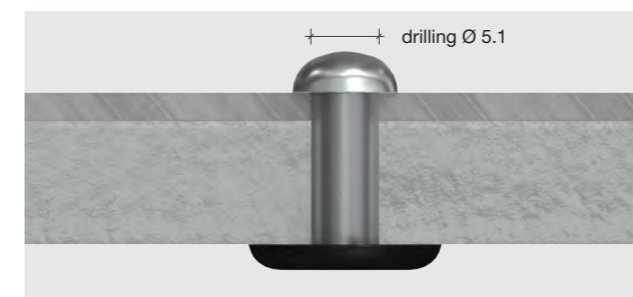

#### Sliding point

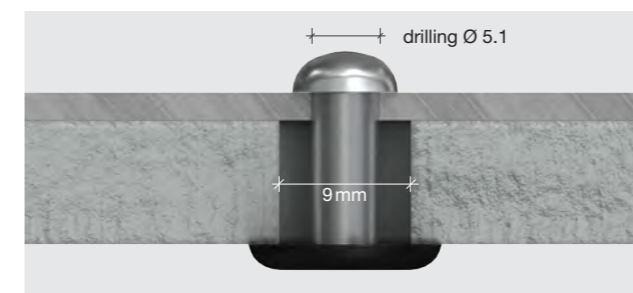

#### Edge corner areas

The following distances apply:

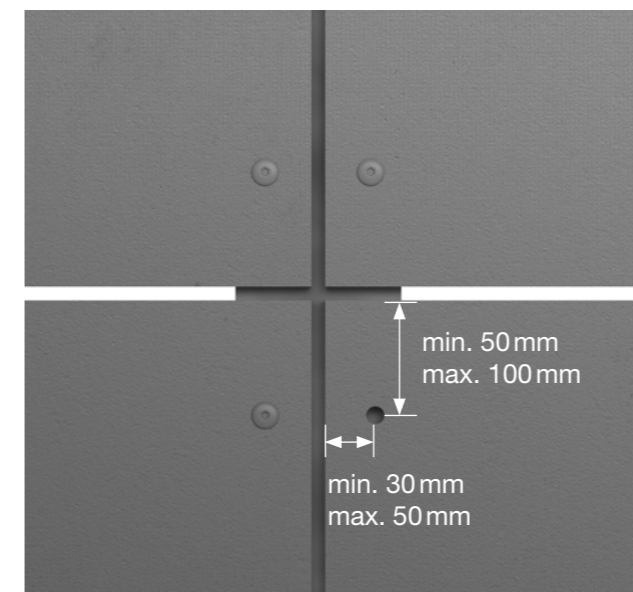

Minimum and maximum edge and corner distances

#### Pre-drilling

When fixing Hardie® Panel & Hardie® Architectural Panel cladding to an aluminium subframe, the cladding panels are pre-drilled lying flat on a level, pressure-resistant substrate.

Dust from drilling must be removed immediately with a microfibre cloth, otherwise traces may remain on the surface.





**Installation procedure**

The hole in the Aluminium subframe must be centered for example by using a centralising tool.

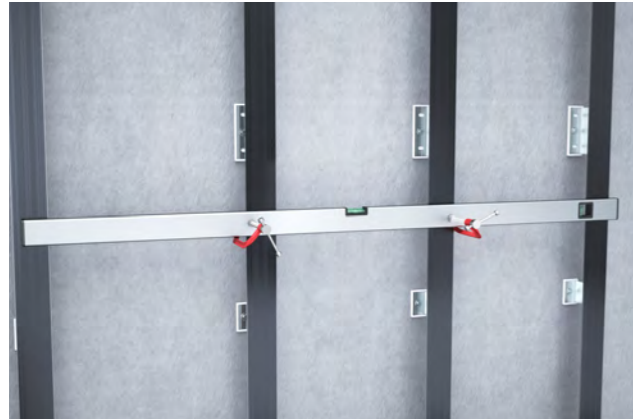

Finally, the facade rivet is set using a rivet setting tool. The rivet head must lie flat on the surface of the facade panel.

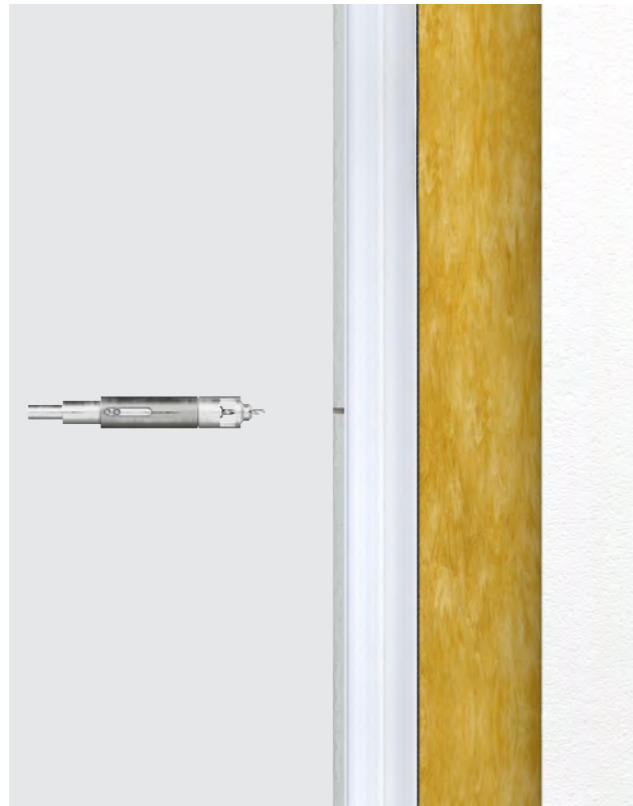

Please note that there are different nosepieces for the rivet setting tool for fixed and sliding points.

For sliding points the nosepiece will ensure that the rivet sits off the face of the panel by 0.3mm.

Care must be taken to ensure that these are selected accordingly. The different nose pieces ensure the correct distance between the rivet head and the facade panel.

The panel fixed points should preferably be located in the centre of the panels in the area of the fixed points within the subframes and should be on a horizontal line.

All other fixings are designed as sliding points. To make the fixings as constraint-free as possible, the fixings should be set in a circle from the inside to the outside.

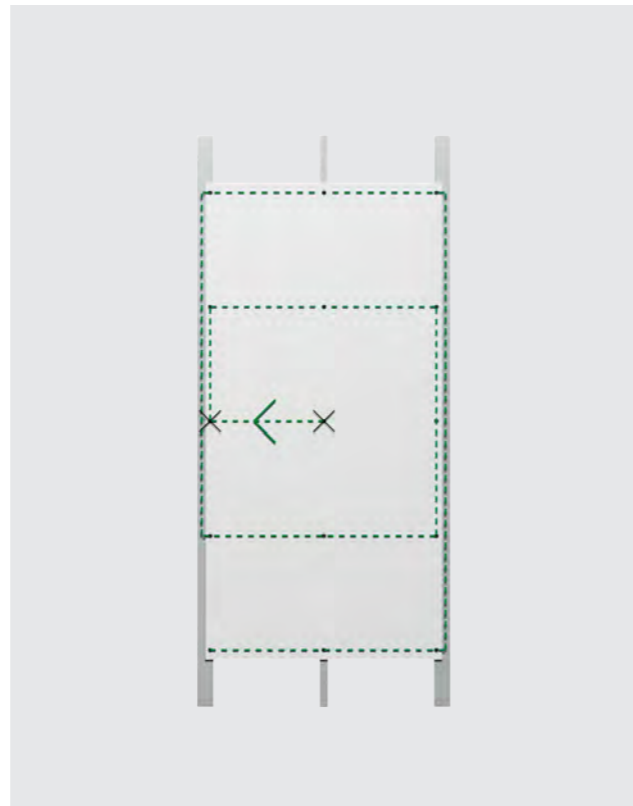

Sequence of rivet fastening, the crosses mark the fixed points

**Example of vertically mounted panels:**



**Example of horizontally mounted panels:**

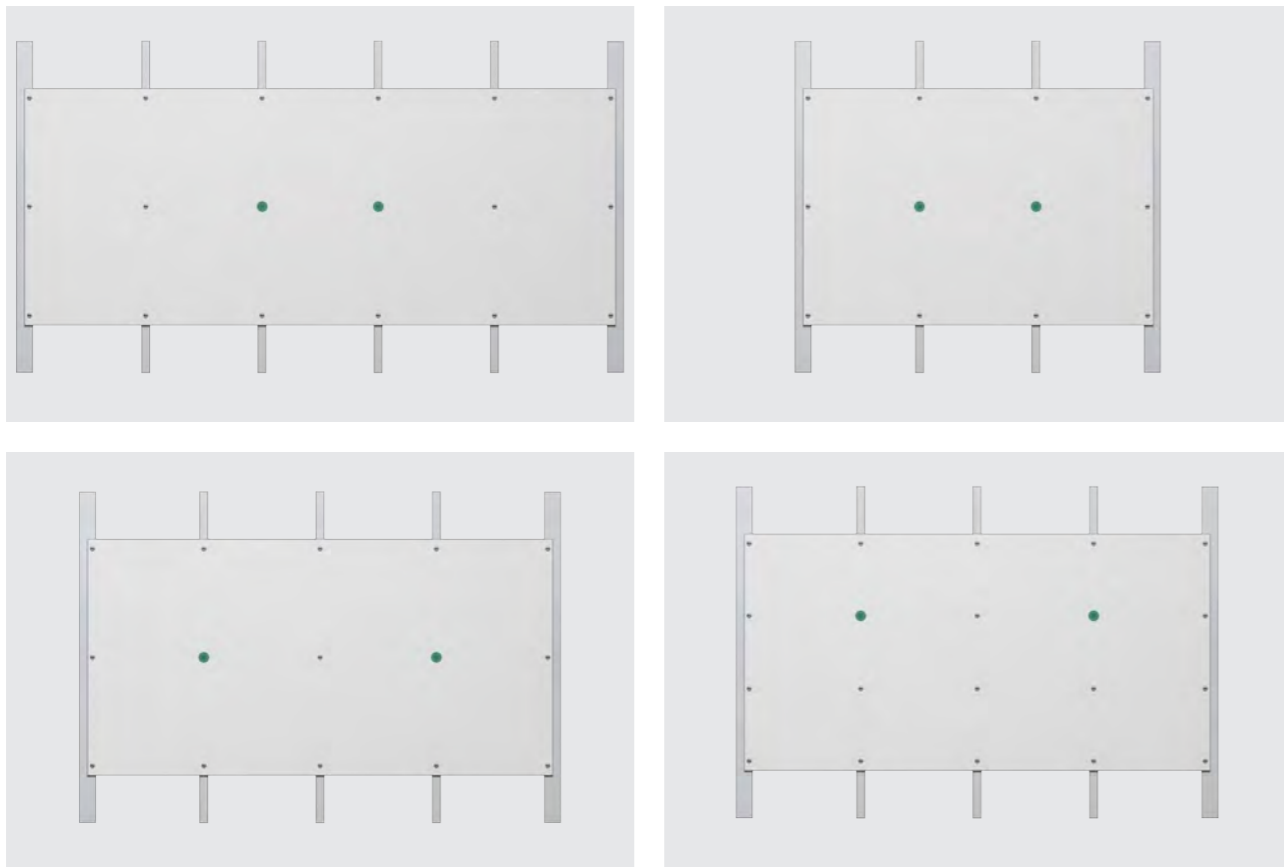

Correct mounting of Hardie® Panel & Hardie® Architectural Panel at windows, doors and openings.

Wrong mounting of Hardie® Panel & Hardie® Architectural Panel at windows, doors and openings.

To reduce the risk of breakage, when installing Hardie® Panel & Hardie® Architectural Panel around windows, doors, and other openings or notched panels, make sure the panels are installed according to the guidelines. James Hardie recommends cutting separate strips around the opening.

**Wind load tables**

Windloading will depend on the location of the build in the UK, including factors such as height above sea level, distance from the coast and other buildings that are in the vicinity according to BS-EN-1991-1-4. Windloading should always be calculated by a qualified engineer.

Possible characteristic wind suction load [kN/m <sup>2</sup> ]					
Board thickness	Frame type	Fixing type	Framing / stud centres	Fixing centres vertically	Published wind pressure result (kPa) inc safety factor
8 mm	Aluminium	Rivet (façade) Aluminium body / stainless mandrel 5 mm x 18 mm x 14 head	600 mm	600 mm	-1.4 kPa
			600 mm	400 mm	-1.8 kPa
			400 mm	600 mm	-1.8 kPa
			400 mm	500 mm	-2.5 kPa
			400 mm	400 mm	-3.0 kPa
			400 mm	400 mm	-3.0 kPa
	Galvanised Steel Top Hats (min 1.5 mm thick)	Screw 5.5 x 35 x 12 mm Low profile bi-metallic self drilling	600 mm	600 mm	-1.4 kPa
			600 mm	400 mm	-1.46 kPa
			400 mm	400 mm	-2.86 kPa
			400 mm	400 mm	-2.86 kPa
11 mm	Aluminium	Rivet (façade) - Aluminium body / stainless mandrel 5.0 x 25 mm 16 mm head Grip range 12.5-18 mm	600 mm	600 mm	-2.2 kPa
			600 mm	600 mm	-2.2 kPa
Galvanised Steel Top Hats (min 1.2 mm thick)	Screw 5.5 x 35 x 12 mm bi-metallic self drilling	600 mm	600 mm	-1.73 kPa	
		600 mm	600 mm	-1.73 kPa	



### 3.2.1 Technical specifications/details

#### I. General spacing

Hardie® Panel and Hardie® Architectural Panel should project 10mm below (at the base) and above (at the roof) the subframes.

The distance to the ground should be at least 150mm from the lower edge of the cladding panel to prevent soiling and damage. If there is no gravel strip, a distance of at least 150mm (splash water area) must be maintained.

For flat roofs, balconies and similar where water can run off, the distance should be at least 50mm. The distance to windowsills and lintels must be at least 10mm.

For vertical connections of the facade panels to profiles or other building components, the distance must be at least 1mm.

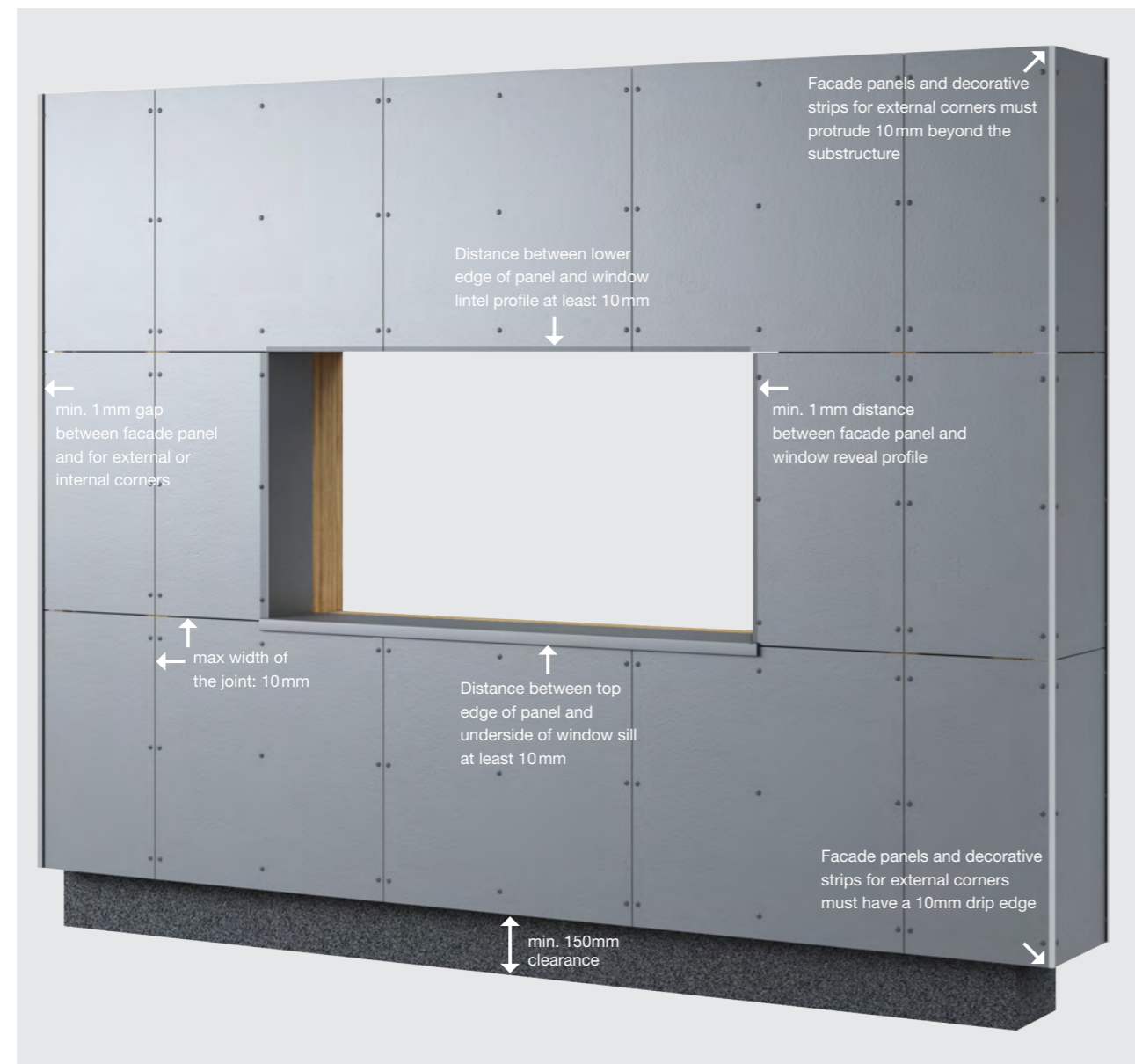

#### II. Fascia

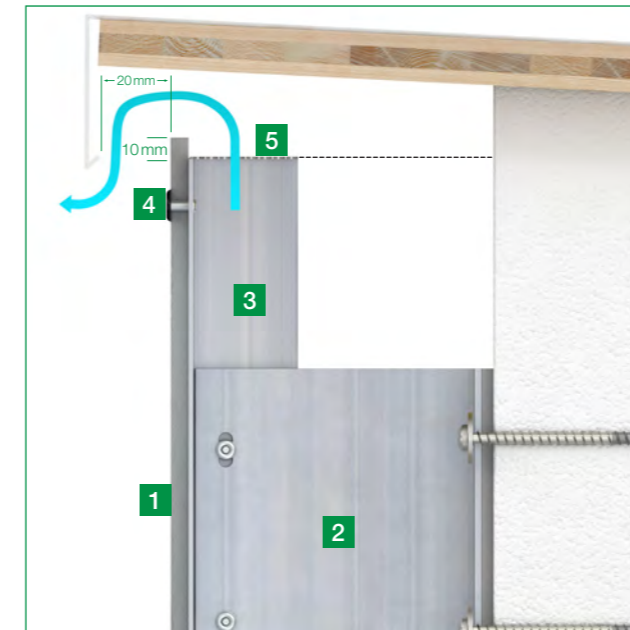

It must be ensured that the air can flow freely behind the facade panel. The facade panel must protrude at least 10mm above the subframes. A ventilation cross-section of min. 50cm<sup>2</sup> per running metre must be used to ensure rear ventilation. A gap of min.

10mm must be ensured from the upper edge of the facade panel to the lower edge of the parapet formation. We recommend the use of a ventilation grille also in the upper area of the facade. The drip edge of the parapet should be at least 20mm in front of the facade. The overlap must be min. 50mm.

#### III. Base section

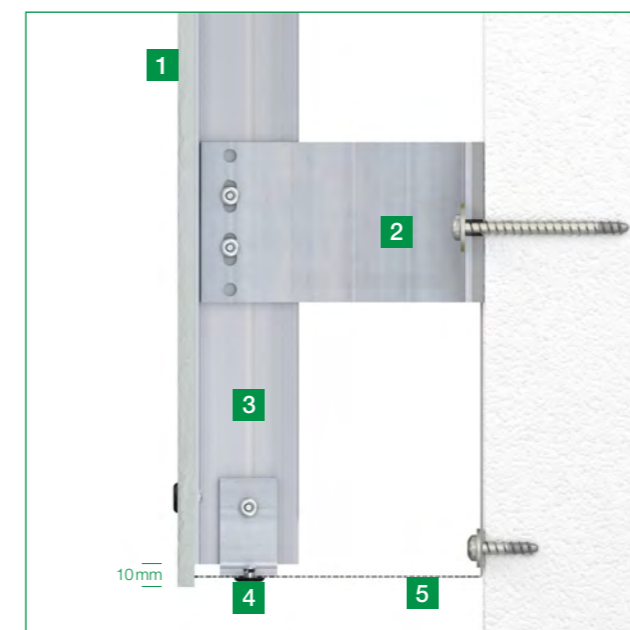

Ensure that the cladding panel has a 10mm drip edge to allow water to run off the cladding. Ventilation profiles must be installed to prevent small rodents from entering.

**IV. Internal corner with open joint**

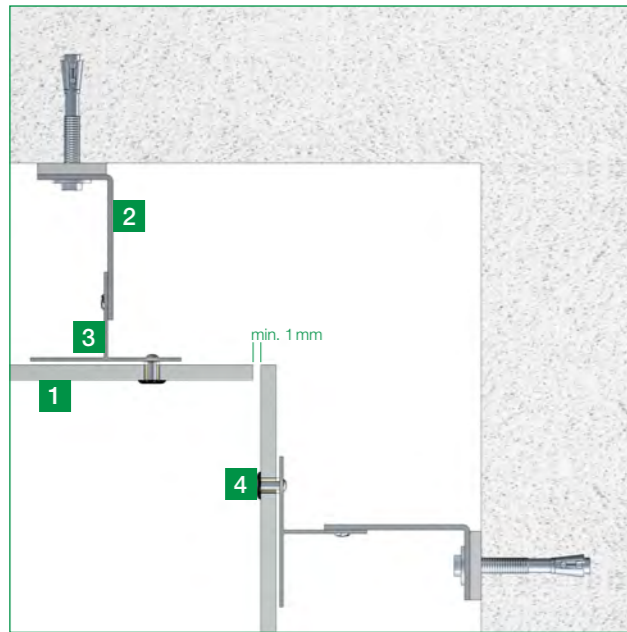

- 1 Hardie® Panel or Hardie® Architectural Panel
- 2 Aluminium wall bracket
- 3 Vertical Aluminium support profile
- 4 Rivets (for Aluminium substructure)

For the internal corner solution with open joint, a joint width of min. 1 mm must be maintained.

**VI. External corner with open joint**

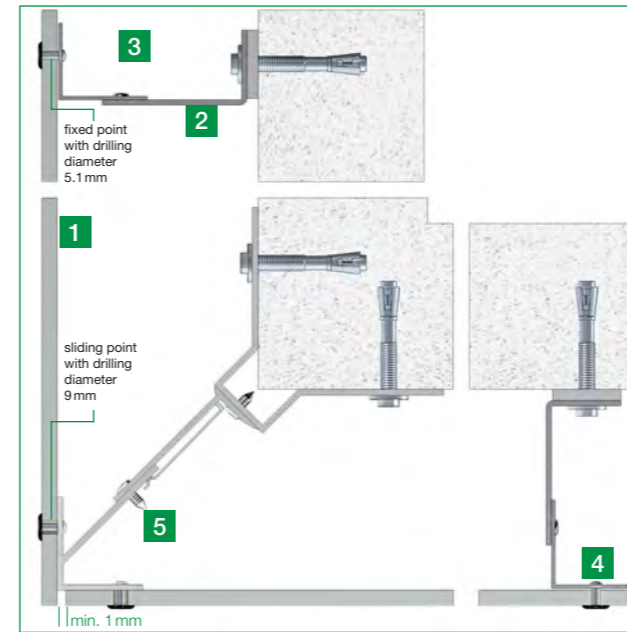

- 1 Hardie® Panel or Hardie® Architectural Panel
- 2 Aluminium wall bracket
- 3 Vertical aluminium support profile
- 4 Rivets (for aluminium substructure)
- 5 Aluminium external corner bracket

For the external corner solution with an open joint, a joint width of min. 1 mm must be maintained.

**V. Internal Corner with metal trim**

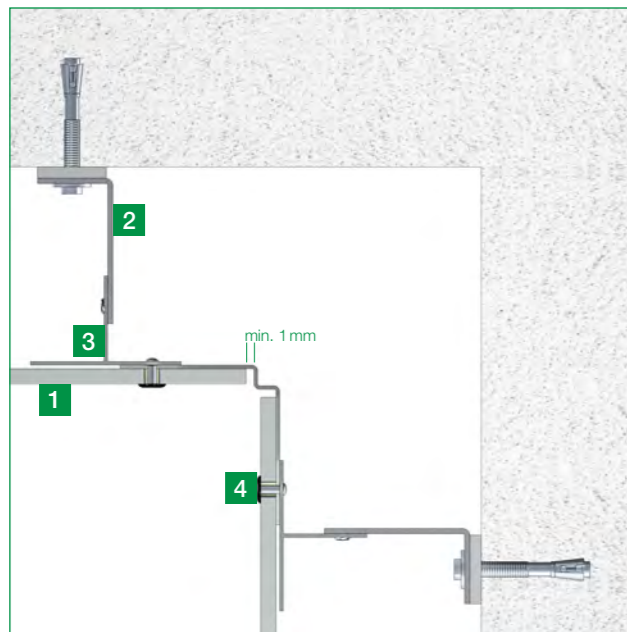

- 1 Hardie® Panel or Hardie® Architectural Panel
- 2 Aluminium wall bracket
- 3 Vertical Aluminium support profile
- 4 Rivets (for Aluminium substructure)

For the internal corner solution with Hardie™ Panel MetalTrim™ trim for internal corners, a joint width of min. 1 mm must be maintained between the outer edge of the facade panel and the profile.

**VII. External corner with Hardie™ Panel MetalTrim™**

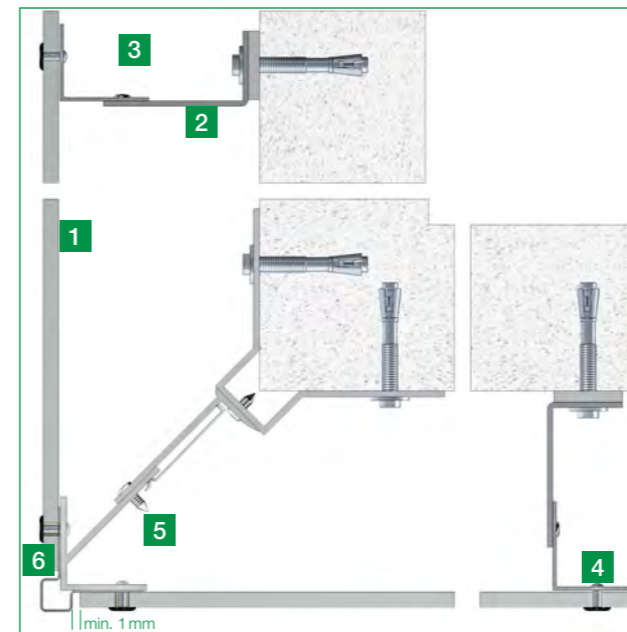

- 1 Hardie® Panel or Hardie® Architectural Panel
- 2 Aluminium wall bracket
- 3 Vertical Aluminium support profile
- 4 Rivets (for Aluminium substructure)
- 5 Aluminium external corner bracket
- 6 Hardie™ Panel MetalTrim™ external corner trim

For the external corner solution with Hardie™ Panel MetalTrim™ trim for external corners, a joint width of min. 1 mm must be maintained between the outer edge of the facade panel and the profile.



**VIII. Window reveal with open joint**

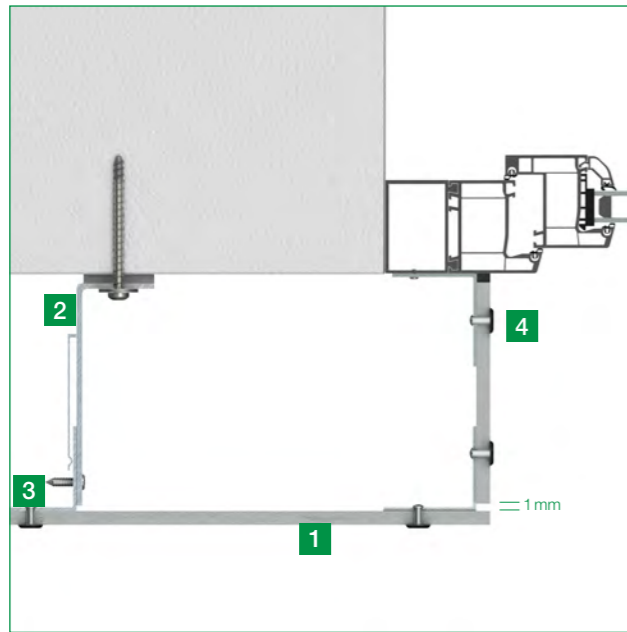

- 1 Hardie® Panel or Hardie® Architectural Panel
- 2 Aluminium wall bracket
- 3 Vertical Aluminium support profile
- 4 Rivets (for Aluminium substructure)

**IX. Window reveal with Hardie™ Panel MetalTrim™**

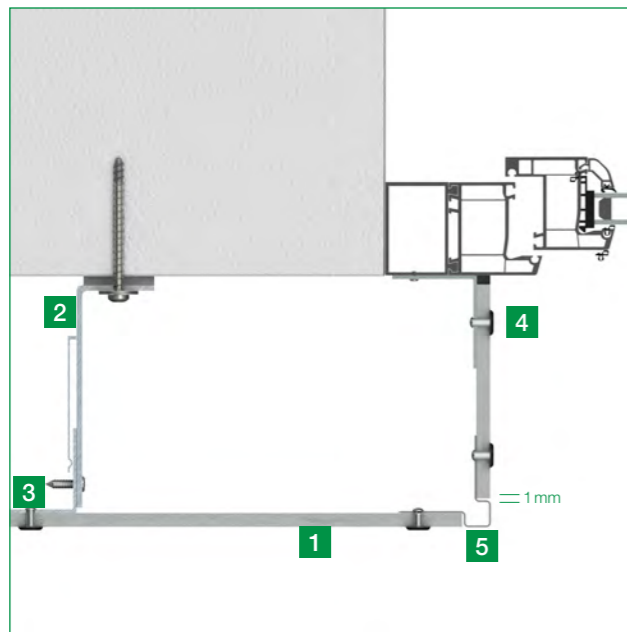

- 1 Hardie® Panel or Hardie® Architectural Panel
- 2 Aluminium wall bracket
- 3 Vertical Aluminium support profile
- 4 Rivets (for Aluminium substructure)
- 5 Hardie™ Panel MetalTrim™ external corner trim

When forming the window reveal with Hardie™ Panel MetalTrim™ trim for external corners, a joint width of min. 1 mm must be maintained between the outer edge of the facade panel and the profile.

**X. Window head**

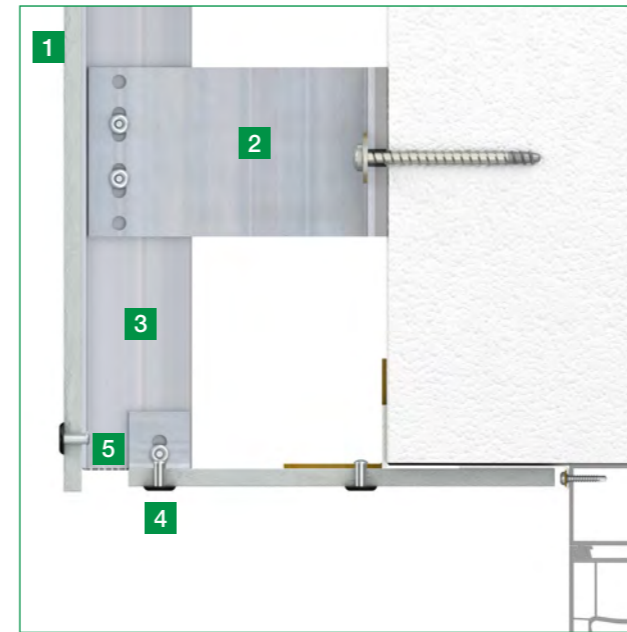

- 1 Hardie® Panel or Hardie® Architectural Panel
- 2 Aluminium wall bracket
- 3 Vertical Aluminium support profile
- 4 Rivets (for Aluminium substructure)
- 5 Ventilation profile for Hardie® Panel

The cladding panels can be fixed with the Hardie™ Panel screw for timber subframes, as on the window reveals. A ventilation gap of min. 20mm must be

made at the front edge of the panel to the facade side. Use Hardie™ ventilation profiles to ensure that no small animals can enter the rear ventilation level.

**XI. Window sill**

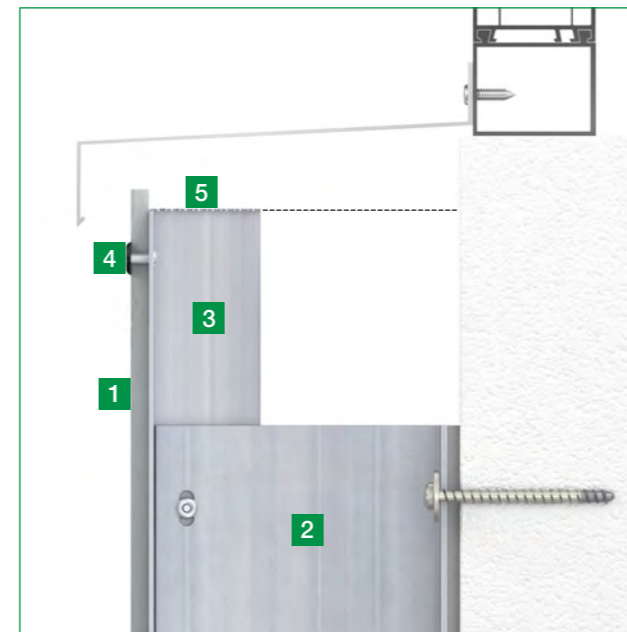

- 1 Hardie® Panel or Hardie® Architectural Panel
- 2 Aluminium wall bracket
- 3 Vertical Aluminium support profile
- 4 Rivets (for Aluminium substructure)
- 5 Ventilation profile for Hardie® Panel

The facade cladding must protrude 10mm above the subframes at the top. To avoid soiling, we recommend that the windowsill protrudes at least 30mm above the facade.

Hardie® Panel and Hardie® Architectural Panel must not be used as a window sill!

There should be at least a gap of 10mm or 50cm² per metre between the upper facade panel and the windowsill for sufficient ventilation.

### 3.3 Cladding of soffits and fascia

Hardie® Panel and Hardie® Architectural Panel can also be used as cladding for soffits or in overhead applications. e.g. from roof overhangs.

It must be taken into account that the panels may only be fixed to a substructure that is anchored directly to the load-bearing component.

Special loads (e.g. from lamps) must generally be transferred to the load-bearing substrate independently of the facade panels.

When using Hardie® Panel and Hardie® Architectural Panel in overhead applications, a maximum centre and fastener spacing should be in reference to the windload. Please refer to the windload tables.

When Hardie® Panel and Hardie® Architectural Panel are used as soffits or roof overhangs, the edge distances are basically identical to installation on the ventilated facade. This also applies to the drilling diameter, the joint widths and the distances to adjacent building components.

For further information please speak to our technical team.

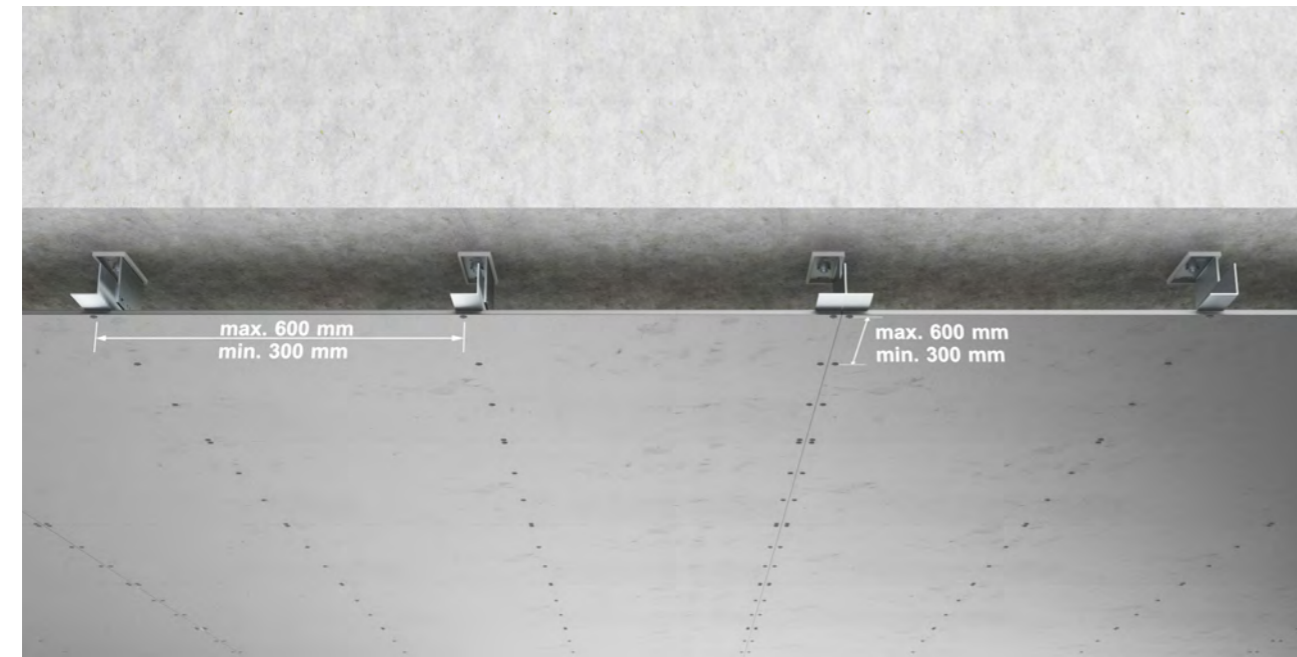

### 3.4 Timber subframes

#### General

The dimensioning of the fixings, connection and anchoring in the substrate is carried out for a timber subframe according to the corresponding specifications of EN 1995-1-1 (Euro Code 5) in conjunction with the national annex. Wooden battens with the minimum strength class C24 (S10) must be used for the subframes.

Screws for timber frames with dimensions 4.8 × 38 mm, head diameter 12 mm must be used for fastening to timber battens.



Construction with vertical battens



### Connection of subframes

The load-bearing battens should be arranged vertically according to local standards and regulations.

### Cross battening

Should you be installing Hardie® Panel vertically, or incorporating insulation within your wall build up cross battening is a viable sub-frame option.

All battens should be pressure treated for the external environment and a minimum of 25mm thick, CS24 grade. Please note that it is critical that a clear air cavity of 20mm+ is maintained when incorporating insulation. The primary batten should be sized to accommodate the insulation thickness.

The secondary / outer batten should be 50mm wide for the single fixing points. 100mm or two 50mm wide battens will be required where there is a Hardie® Panel joint.

*EPDM should always be stapled over the batten face when there is a Hardie® Panel joint. This is to protect the timber from driving rain and long term exposure.*



Vertical batten with horizontal batten & panel on the face & screw fixing



Horizontal batten with insulation slotted in. Vertical batten on the top with panel finish & screw

### Minimum cross-section of the timber subframes

Hardie® Panel and Hardie® Architectural Panel must always be installed free of constraints.

Care must be taken to ensure that the joint width between the panels is specified at the planning stage. A maximum joint width of 10mm may be used. The optimum joint width is 8mm. During installation, a uniform parallel joint pattern must be maintained. With a joint width of max. 10mm, the following minimum dimensions of the load-bearing battens result:

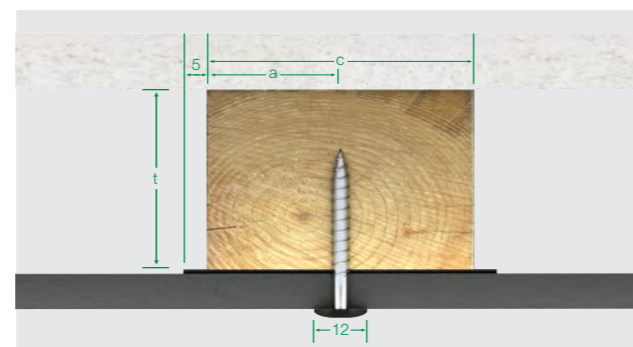
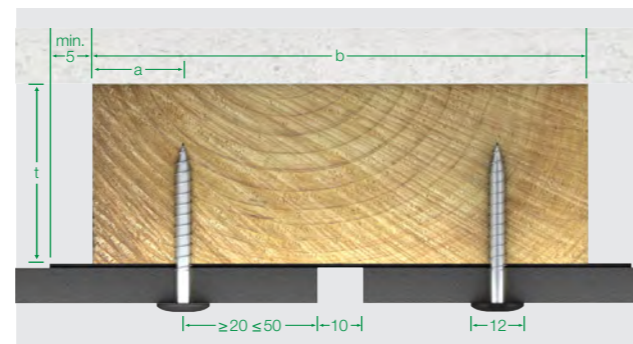

Minimum distance in mm	
Minimum thickness of the battens (t)	≥ 38
Minimum edge distance (a)	≥ 20
Minimum width of the batten (c)	≥ 50
Minimum width of the batten (b)	≥ 100

### 3.4.1 Fastening to timber battens

#### Edge corner areas

The following distances apply:

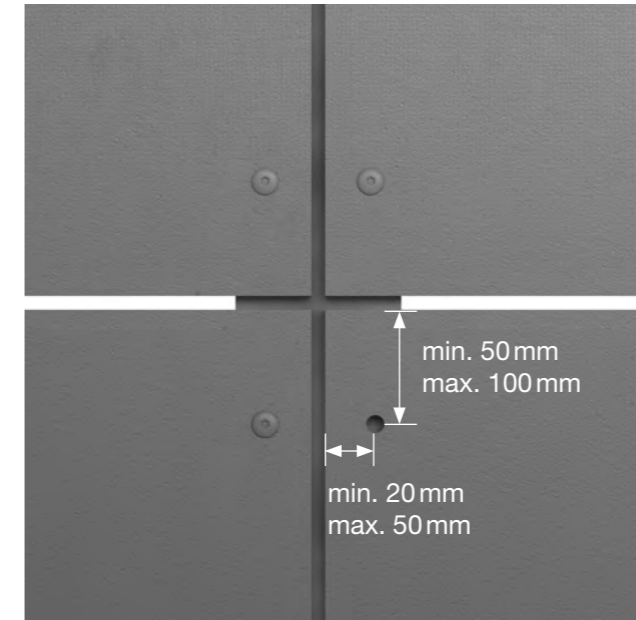

Minimum and maximum edge and corner distances

On a wooden subframe, no sliding points need to be provided in the panel.

It is recommended to mark the fixing points on the facade panel in advance. When marking the fastening points, make sure that the marks are smaller than the head of the fastener.

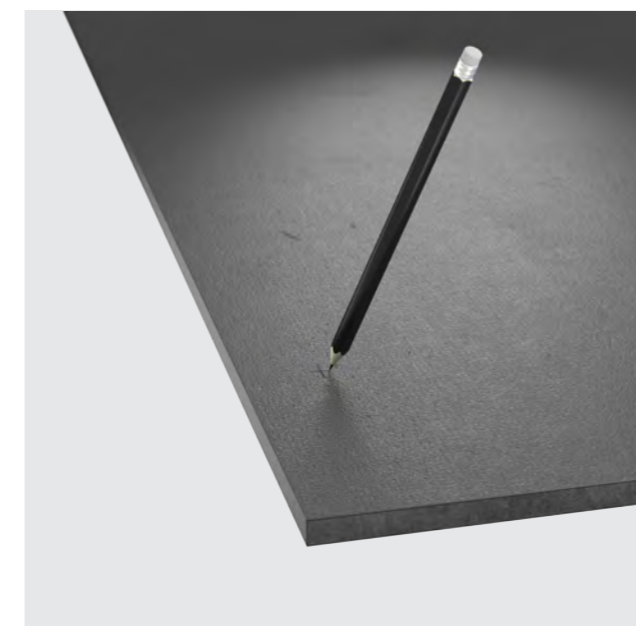

When marking, make sure that the marking is smaller than the fastener

Removing the markings later can damage the paint coating.

#### Pre-drilling

When fixing Hardie® Panel & Hardie® Architectural Panel to timber subframes, the cladding panels can be pre-drilled, but this is not essential.



Remove drilling dust from the surface immediately

The drill diameter for timber subframe is max. 4mm

The screws are to be hand-guided when screwing in with the appropriate Torx 20 bit, the screw is screwed in with moderate pressure.

The screw head should rest fully and flat on the panel surface. Take care not to over tighten the fixing.

**Dust from drilling must be removed immediately, otherwise traces may remain on the surface.**

**Fixing centres**

The maximum centre distance and fixing spacing of Hardie® Panel & Hardie® Architectural Panel is 600mm.

- 1 Load-bearing substrate
- 2 Vertically mounted support battens
- 3 Hardie™ EPDM tape
- 4 In accordance with building regulations

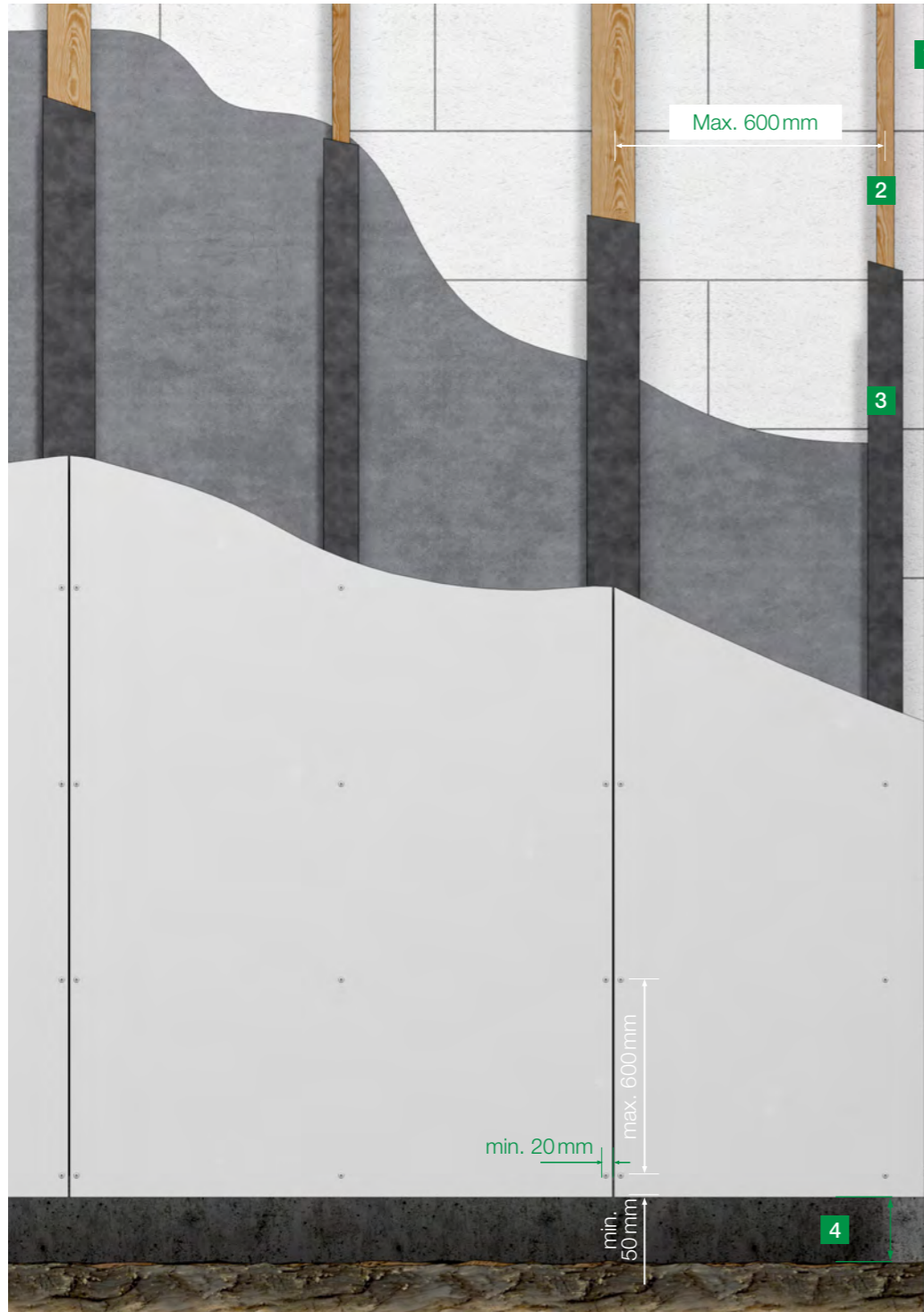

**Wind load table**

Windloading will depend on the location of the build in the UK, including factors such as height above sea level, distance from the coast and other buildings that are in the vicinity according to BS-EN-1991-1-4. Windloading should always be calculated by a qualified engineer.

Possible characteristic wind suction load [kN/m <sup>2</sup> ]					
Board depth	Frame type	Fixing type	Framing / stud centres	Fixing centres vertically	Published wind pressure result (kPa) inc safety factor
8 mm	Timber	Screw 4.8 x 38 mm x 12 mm head Stainless Steel	600 mm	600 mm	-1.13 kPa
	Timber	Screw 4.8 x 38 mm x 12 mm head Stainless Steel	600 mm	400 mm	-1.60 kPa
	Timber	Screw 4.8 x 38 mm x 12 mm head Stainless Steel	400 mm	400 mm	-2.73 kPa
11 mm	Timber	Hardie™ Panel Screw 4.8 x 38 x 12 mm head 304 grade Stainless Steel	600 mm	600 mm	-2.26 kPa



### 3.4.2 Technical specifications/details

#### I. General spacings

Please refer to the specified spacings in this brochure.

Hardie® Panel and Hardie® Architectural Panel should project 10 mm below (at the base) and above (at the roof) the subframes.

For flat roofs, balconies and similar where water can run off, the distance should be at least 50 mm.

The distance to window sills and lintels must be at least 10 mm.

For vertical connections of the facade panels to profiles or other building components, the distance must be at least 1 mm.

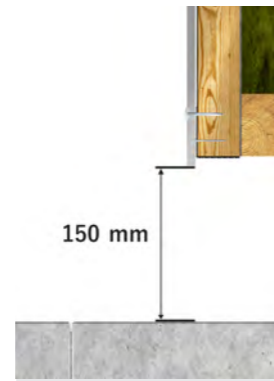

The lower edge of the facade panel is advised to be placed with at least 150 mm distance in the splash water area or 150 mm in case of a surrounding gravel bed.

#### II. Parapet

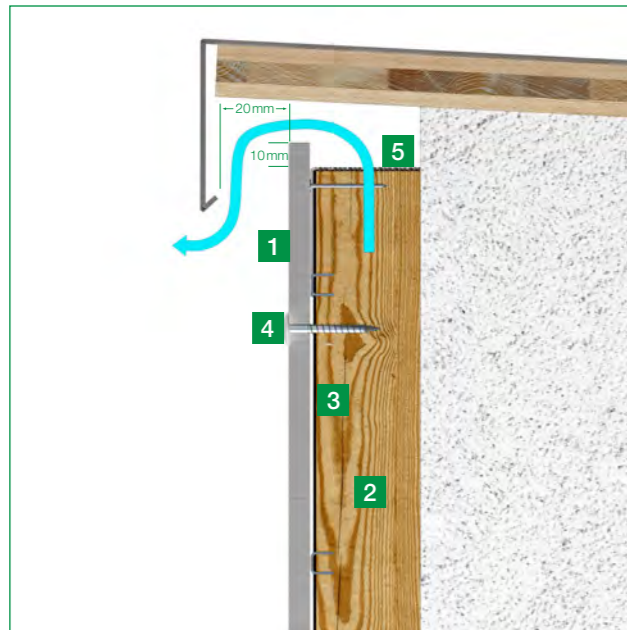

- 1 Hardie® Panel or Hardie® Architectural Panel
- 2 Vertical battens
- 3 Hardie™ EPDM tape
- 4 Screws (for timber frames)
- 5 Ventilation profile for Hardie® Panel

be used to ensure rear ventilation. A gap of min. 10 mm must be ensured from the upper edge of the facade panel to the lower edge of the parapet formation. We recommend the use of a ventilation grille also in the upper area of the facade. The drip edge of the parapet should be at least 20 mm in front of the facade. The overlap must be min. 50 mm.

It must be ensured that the air can flow freely behind the facade panel. The facade panel must protrude at least 10 mm above the subframes. A ventilation cross-section of min. 50 cm<sup>2</sup> per running metre must

#### III. Base section

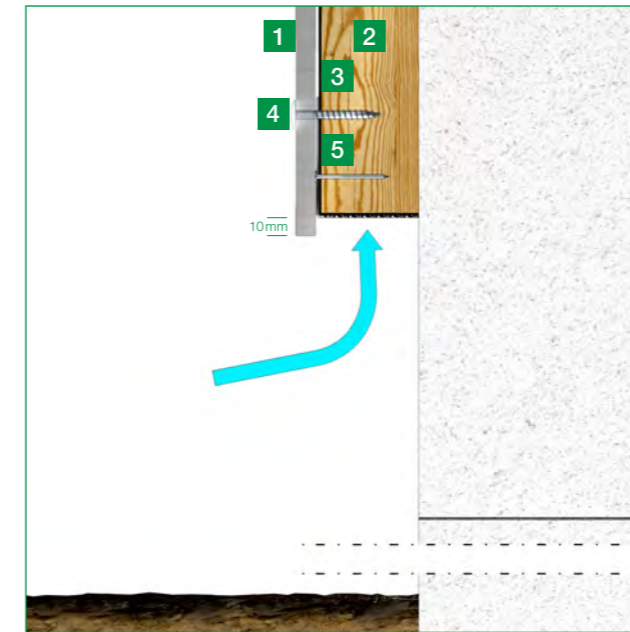

- 1 Hardie® Panel or Hardie® Architectural Panel
- 2 Vertical battens
- 3 Hardie™ EPDM tape
- 4 Screws (for timber frames)
- 5 Ventilation profile for Hardie® Panel

Ensure that the cladding panel overlaps the subframes by 10 mm to allow water to run off the cladding. Ventilation profiles must be installed to prevent small rodents from entering.

#### IV. External corner with open joint:

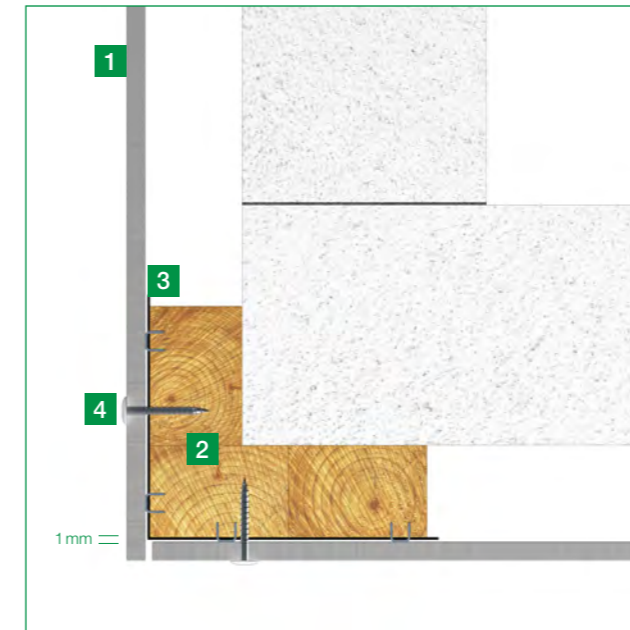

- 1 Hardie® Panel or Hardie® Architectural Panel
- 2 Vertical battens
- 3 Hardie™ EPDM tape
- 4 Screws (for timber frames)

For the external corner with an open joint, a joint width of min. 1 mm must be maintained. The Hardie™ EPDM tape must be used over the entire width of the subframes.

**V. External corner with Hardie™ Panel MetalTrim™**



- 1 Hardie® Panel or Hardie® Architectural Panel
- 2 Vertical battens
- 3 Hardie™ EPDM tape
- 4 Screws (for timber frames)
- 5 Hardie™ Panel MetalTrim™ external corner trim

For the external corner solution with Hardie™ Panel MetalTrim™ trim for external corners, a joint width of min. 1 mm must be maintained between the outer edge of the facade panel and the profile.

**VII. Internal Corner with metal trim**

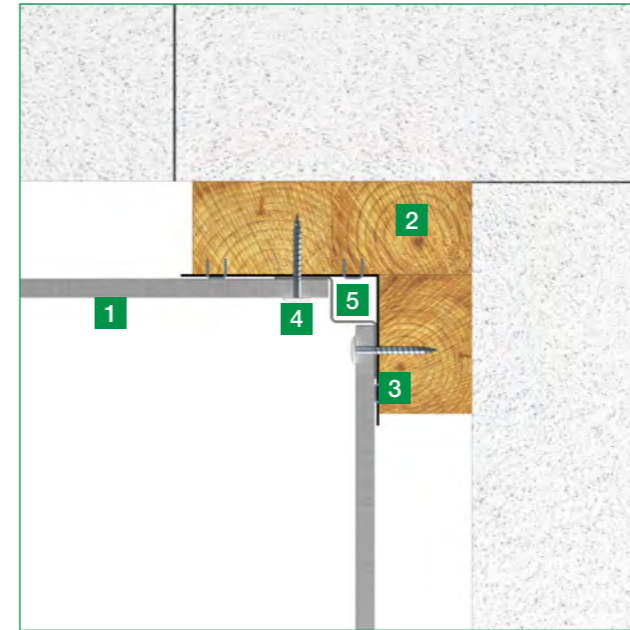

- 1 Hardie® Panel or Hardie® Architectural Panel
- 2 Vertical battens
- 3 Hardie™ EPDM tape
- 4 Screws (for timber frames)
- 5 Metal trim strips for inside corners

For the internal corner solution with Hardie™ Panel MetalTrim™ trim for internal corners, a joint width of min. 1 mm must be maintained between the outer edge of the facade panel and the profile.

**VI. Internal corner with open joint:**

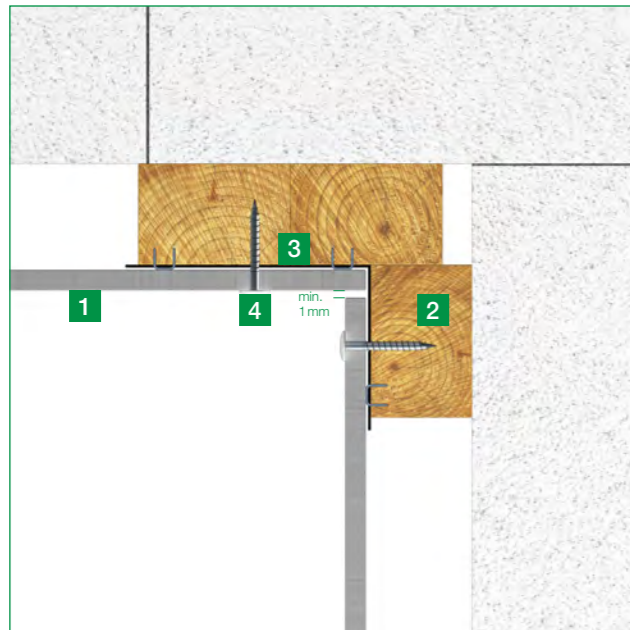

- 1 Hardie® Panel or Hardie® Architectural Panel
- 2 Vertical battens
- 3 Hardie™ EPDM tape
- 4 Screws (for timber frames)

For the internal corner solution with open joint, a joint width of min. 1 mm must be maintained. The Hardie™ EPDM tape must be used over the entire width of the subframes.

**VIII. Window reveal with open joint**

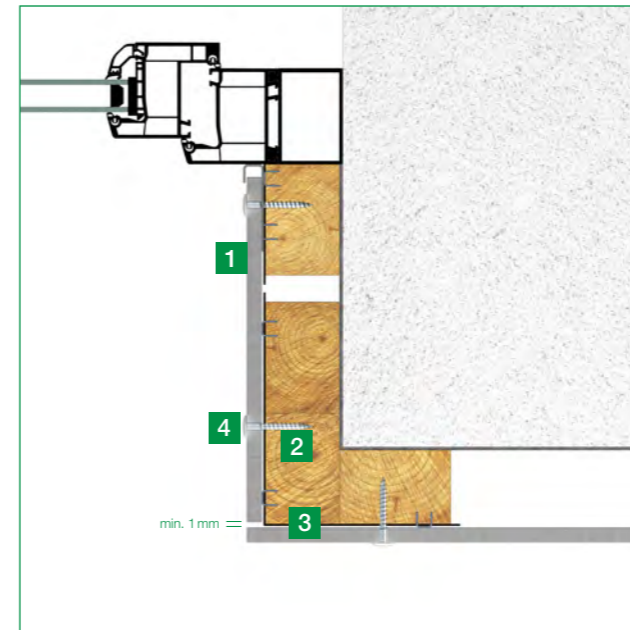

- 1 Hardie® Panel or Hardie® Architectural Panel
- 2 Vertical battens
- 3 Hardie™ EPDM tape
- 4 Screws (for timber frames)

The timber subframes in the corner area must be provided with the Hardie™ EPDM tape over the entire width. The width of the joint at the corners between the facade panels should not be less than 1 mm.



**IX. Window reveal with Hardie™ Panel MetalTrim™**

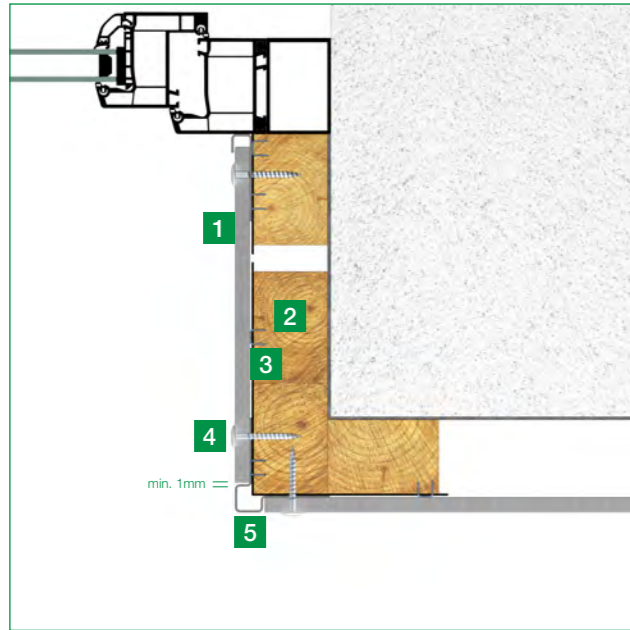

- 1 Hardie® Panel or Hardie® Architectural Panel
- 2 Vertical battens
- 3 Hardie™ EPDM tape
- 4 Screws (for timber frames)
- 5 Hardie™ Panel MetalTrim™ external corner trim

When forming the window reveal with Hardie™ Panel MetalTrim™ trim for external corners, a joint width of min. 1 mm must be maintained between the outer edge of the facade panel and the profile.

**XI. Window head**

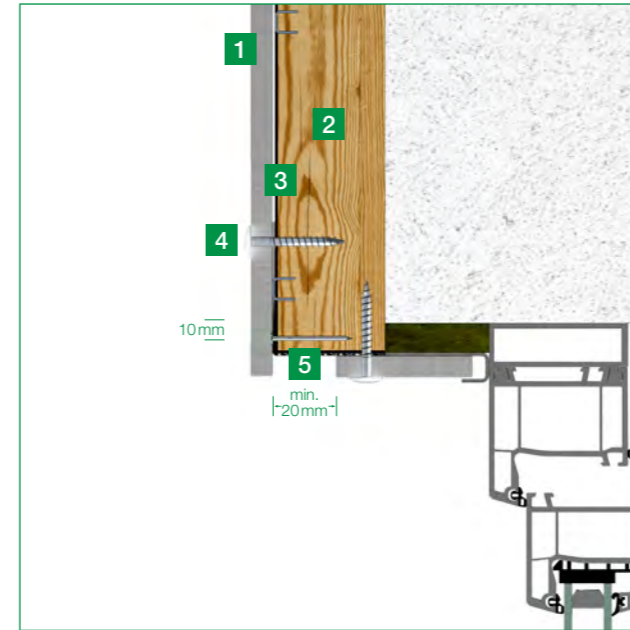

- 1 Hardie® Panel or Hardie® Architectural Panel
- 2 Vertical battens
- 3 Hardie™ EPDM tape
- 4 Screws (for timber frames)
- 5 Ventilation profile for Hardie® Panel

The cladding panels can be fixed with the Hardie™ Panel screw for timber subframes, as on the window reveals. A ventilation gap of min. 20 mm

must be made at the front edge of the panel to the facade side. Use Hardie™ ventilation profiles to ensure that no small animals can enter the rear ventilation level.

**X. Window sill**

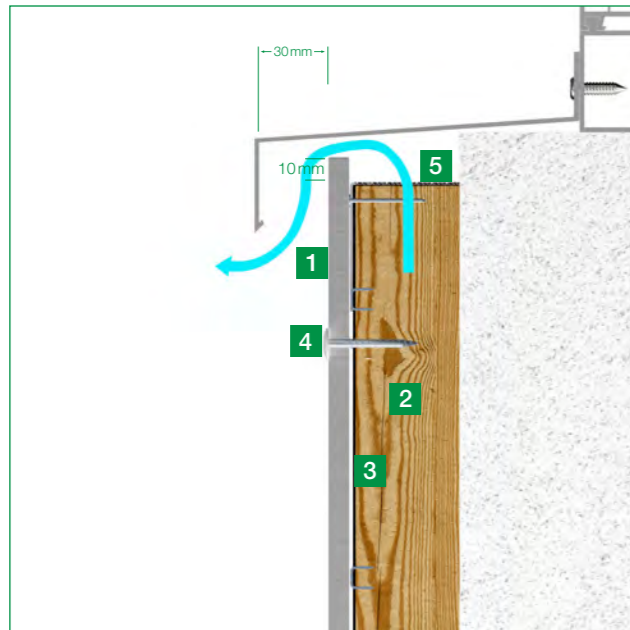

- 1 Hardie® Panel or Hardie® Architectural Panel
- 2 Vertical battens
- 3 Hardie™ EPDM tape
- 4 Screws (for timber frames)
- 5 Ventilation profile for Hardie® Panel

The facade cladding must protrude 10 mm above the subframes at the top. To avoid soiling, we recommend that the windowsill protrudes at least 30 mm above the facade.

Hardie® Panel and Hardie® Architectural Panel must not be used as a window sill!

There should be at least a gap of 10 mm or 50 cm<sup>2</sup> per metre between the upper facade panel and the window sill for sufficient ventilation.





Please always check the latest version of the installation guide. The latest version can always be found on the website.

Version Date: 02/2025

© 2025 James Hardie Europe GmbH.  
™ and ® denote registered and unregistered trademarks of James Hardie Technology Limited and James Hardie Europe GmbH.

**James Hardie Building Products Ltd**

4 & 5 The Priors  
London Road  
Canwell  
Sutton Coldfield  
B75 5SH

Tel. +44 (0) 121 311 3480  
Fax +44 (0) 121 311 1882  
[www.jameshardie.co.uk](http://www.jameshardie.co.uk)

har-400-00001/02.25/m

